

Alarm model:

Sold on:

By:

Installed on bike  
model, number

**GEMINI Technologies S.r.l.**

Via Luigi Galvani 12 - 21020 Bodio Lomnago (VA) - Italy

Tel. +39 0332 943211 - Fax +39 0332 948080

[www.gemini-alarm.com](http://www.gemini-alarm.com)

ISO 9001 Certified company



# 953N

## USER AND INSTALLER MANUAL



CE  
Made in Italy

REV.01 - 05/17



## CONTENTS

### 1.0 - INTRODUCTORY NOTE

#### **USER MANUAL**

### 2.0 - ALARM SYSTEM CONTROL DEVICES

### 3.0 - SYSTEM OPERATION - BASIC CONFIGURATION

#### 3.1 - Arming

#### 3.2 - Top case/seat open warning

#### 3.3 - Arming delay

#### 3.4 - Siren exclusion

#### 3.5 - Tilt sensor exclusion

#### 3.6 - Full arming

#### 3.7 - Alarm events

#### 3.8 - Limitation of audible alarms

#### 3.9 - Neutral time between alarm events

#### 3.10 - System disarming without alarm memory

#### 3.11 - System disarming with alarm memory

### 4.0 - PROGRAMMABLE FEATURES

#### 4.1 - Optical/acoustic signals

#### 4.2 - Panic alarm via remote control

#### 4.3 - Tilt sensor

#### 4.4 - Tilt sensor temporary exclusion

#### 4.5 - Passive arming

#### 4.6 - Anti-hijack feature

#### 4.7 - Pre-alarm

#### 4.8 - Self-rearming

### 5.0 - SLEEP MODE - ENERGY SAVER FEATURE

### 6.0 - HAZARD WARNING FLASHERS

### 7.0 - PIN CODE OVERRIDE

### 8.0 - PIN CODE OVERRIDE EXAMPLE

### 9.0 - PIN CODE CUSTOMIZATION

### 10.0 - REPLACING REMOTE CONTROL BATTERIES

### 11.0 - TECHNICAL SPECIFICATIONS

### 12.0 - WASTE ELECTRICAL AND ELECTRONIC EQUIPMENT (WEEE)

#### DIRECTIVE

### 13.0 - USE AND MAINTENANCE

### 14.0 - WARRANTY CONDITIONS

## CONTENTS

#### **INSTALLER MANUAL**

### 15.0 - FITTING INSTRUCTIONS

### 16.0 - ALARM UNIT SEALING

### 17.0 - ALARM UNIT POSITIONING

### 18.0 - ACCESSORIES - FITTING

#### 18.1 - Status LED

#### 18.2 - Contact switch (optional)

#### 18.3 - Anti-hijack button (optional)

### 19.0 - PINOUT TABLE

### 20.0 - WIRING DIAGRAM

### 21.0 - IMMOBILIZER CONNECTIONS (grounded wire)

### 22.0 - IMMOBILIZER CONNECTIONS (cut wire)

### 23.0 - DIODE INSTALLATION

### 24.0 - LEARNING NEW DEVICES

#### 24.1 - With Brown/Green wire grounded

#### 24.2 - Without grounding the Brown/Green wire

### 25.0 - PROGRAMMABLE FEATURES

### 26.0 - PROGRAMMING EXAMPLE

## 1.0 - INTRODUCTORY NOTE

Dear customer,

This self-powered alarm system, designed and manufactured in Italy specifically for 2-wheeled vehicles, is supplied with 2 remote controls.

The alarm is factory programmed but the features can be user-customized.

Please read the present manual carefully to familiarize yourself fully with the alarm features and operating procedures and do keep it handy for future reference.



The 953N alarm system cannot be paired with transponder TAG 908.

The following signal words are included in the present manual to emphasize important instructions and to alert the user/installer to potential hazards:

### ⚠ ATTENTION

Non compliance to this instruction could result in serious damage to the vehicle and to the alarm system.

### CAUTION

Non compliance to this instruction may cause damage or operational failures to the alarm system.

## USER MANUAL

### 2.0 - ALARM SYSTEM CONTROL DEVICES

The remote controls are used to operate the alarm system. A PIN code can be entered to emergency override the system should the remotes be lost or inoperative.

Override PIN code is entered by means of the vehicle ignition key (see chapter 8.0).

The remote control has a low charge battery indicator that gives early warning to avoid malfunctioning. When the batteries are low, the LED will blink when a button is pressed. Replace the batteries: weak batteries will prevent the remote control from properly operating the alarm system.

The remote control has 2 buttons that activate several functions based on the alarm configuration:

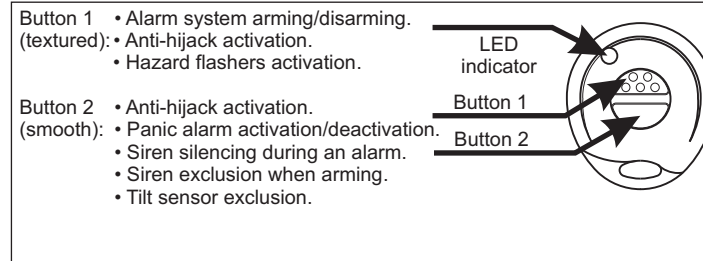

## 3.0 - SYSTEM OPERATION - BASIC CONFIGURATION

### 3.1 - ARMING

To arm the system, press remote control button "1". Arming is confirmed by 2 Beeps and 1 flash of the turn indicators and the status LED turns ON steady.

### 3.2 - TOPCASE/SEAT OPEN WARNING

If, when arming the system, the topcase or the seat are open or incorrectly closed, 1 Bop will sound after the arming confirmation tones.

The system will arm but an alarm condition will be triggered after the arming delay.

### 3.3 - ARMING DELAY

After the arming confirmation tones, the LED turns ON steady for approx. 20 sec. to signal the arming delay countdown.

The engine immobilizer and optional module outputs are enabled during the arming delay.

### 3.4 - SIREN EXCLUSION

During the first 4 sec. of the arming delay, the siren can be excluded by pressing remote control button "2".

Siren exclusion is confirmed by a quick flash of the turn indicators.

#### CAUTION

If the siren is excluded, only the turn indicators will flash during an alarm event. Siren exclusion is bound to a single arming cycle.  
The engine immobilizer feature remains enabled.

### 3.5 - TILT SENSOR TEMPORARY EXCLUSION

When the system is disarmed, turn ignition key in "ON". As the LED lights up, approx. 1 sec., press remote control button "2". The status LED will blink once to confirm that the sensor has been excluded.

The sensor cannot be excluded if the passive arming feature is enabled.

#### CAUTION

Exclusion is bound to a single arming cycle.

### 3.6 - ARMED CONDITION

After the 20 sec. arming delay, the system is fully armed and ready to detect any irregularity. The LED will start flashing to confirm the armed condition.

### 3.7 - ALARM EVENTS

If an alarm event is detected during the armed state, the siren will sound, the LED will turn ON steady and the turn indicators will flash repeatedly for approx. 30 sec.

The following irregularities will trigger an alarm if the relative sensors have been enabled:

- Cable cut tamper detection.
- Ignition attempt.
- Tilt detection.
- Seat/topcase tampering (if protected by a contact switch).
- Panic alarm (by pressing remote control button "2").

After the alarm cycle, the system returns in armed mode.

To interrupt the siren and the flashing of the turn indicators during an alarm event, without disarming the system, press remote control button "2".

### 3.8 - LIMITATION OF AUDIBLE ALARMS

Alarm events caused by unauthorized motion, seat/topcase tampering or ignition attempts will trigger the siren for 7 consecutive cycles.

The siren will then be automatically excluded for the following reasons:

- To comply with the regulations in force aimed at limiting noise pollution.
- To save power and maximize vehicle battery life.
- If, after 7 cycles, no one checks the vehicle, it is useless to have it sound again.

### 3.9 - NEUTRAL TIME BETWEEN ALARM EVENTS

Once the alarm cycle is over, further alarm events will be ignored for 5 sec.; the LED will be ON steady.

During neutral time, the system can be disarmed via PIN code (see par. 7.0 and 8.0).



### 3.10 - SYSTEM DISARMING WITHOUT ALARM MEMORY

To disarm the system, press remote control button "1". The status LED will turn OFF and disarming will be confirmed by 3 Beeps and 3 flashes of the turn indicators.

### 3.11 - SYSTEM DISARMING WITH ALARM MEMORY

If an alarm event occurs while away from the vehicle, it will be signaled on disarming, by 2 flashes of the turn indicators and 2 Bops.

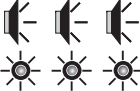
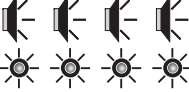
The last cause of alarm can be identified by observing the status LED and counting the flashes.

<b>Ignition attempt:</b>	
<b>Seat/Topcase</b>	
<b>Cable tampering:</b>	
<b>Tilt detection:</b>	

## 4.0 - PROGRAMMABLE FEATURES

The alarm system is factory preset with some features enabled and others disabled as detailed below.

<i>Factory settings</i>	
<b>Feature</b>	<b>Status</b>
Acoustic signals	Enabled
Panic alarm	Enabled
Tilt sensor	Enabled
Passive arming	Disabled
Anti-hijack	Disabled
Pre-alarm	Disabled
Self-rearming (anti-distraction)	Disabled

### 4.1 - OPTICAL/ACOUSTIC SIGNALS

Operations such as arming/disarming, system programming, alarm memory and learning new devices are signaled both acoustically and optically (LED and turn indicators).

Optical/acoustic signals can be excluded.

### 4.2 - PANIC ALARM VIA REMOTE CONTROL

For use in emergency situations. Panic alarms can be triggered as many times as necessary but at least 5 sec. must elapse between 2 consecutive alarms.

Pressing remote control button "2" will immediately activate the siren and the turn indicators for approx. 30 sec. To turn off the panic alarm simply press button "2" again.

The panic alarm can be triggered with either an armed or disarmed system.

### 4.3 - TILT SENSOR

When the system is armed, the sensor will trigger an alarm whenever motion is detected.

### 4.4 - TEMPORARY EXCLUSION OF TILT SENSOR

When the system is disarmed, turn ignition key in "ON". As the LED lights up, approx. 1 sec., press remote control button "2". The status LED will blink once to confirm that the sensor has been excluded.

The sensor cannot be excluded if the passive arming feature is enabled.

#### CAUTION

Exclusion is bound to a single arming cycle.

### 4.5 - PASSIVE ARMING

The system can be programmed to automatically arm every time ignition is turned OFF making sure the vehicle will not be left unprotected.

When ignition is switched OFF, the turn indicators flash once, the status LED twice and the siren chirps twice to signal the passive arming countdown.

The system fully arms (passive arming) 35 sec. after ignition is turned OFF. A flash of the turn indicators and 2 Beeps will confirm the system is armed. The LED will also power ON steady.

To interrupt passive arming, turn ignition ON within 35 sec. of turning it OFF.

Lifting the seat/topcase (if protected by a contact switch) during the 35 sec. arming delay will cause the procedure to interrupt; it will resume once the seat/topcase is closed.

#### 4.6 - ANTI-HIJACK FEATURE

To activate the anti-hijack feature while the engine is running, either:

- Press remote control button "1".
- Press remote control button "2".
- Press the anti-hijack button (if installed).

The LED will turn ON steady and the turn indicators will flash twice to confirm the anti-hijack feature has been activated.

20 sec. after the anti-hijack feature has been activated, the siren will sound for approx. 1 min. while the turn indicators will flash until the anti-hijack mode is deactivated. The system will kill the engine 2 sec. after the siren is triggered.

To exit the anti-hijack mode:

- Use the override key (if available).
- Press the anti-hijack button for 2 sec. (if installed).
- Enter the PIN code.

To exit the anti-hijack mode via PIN code proceed as follows:

- Wait for the siren to stop wailing.
- If ignition key is in the ON position, turn it OFF.
- If key is in the OFF position, cycle it ON and OFF.
- After 4 sec. there will be a sequence of 9 LED flashes.
- From this point on, proceed as indicated in par. 7.0 and 8.0.
- Disarming via PIN code will be confirmed by 3 Beep and 3 flashes of the turn indicators.



The anti-hijack mode has a memory feature.  
If the power supply is disconnected and subsequently reconnected an alarm will be triggered because it will be considered a theft attempt.

#### 4.7 - PRE-ALARM MODE

If the pre-alarm feature is enabled, the siren, during an alarm condition (ex. tilt), will start sounding for approx. 2.5 sec. for the first 3 cycles, then from the 4th cycle on, it will sound for 30 sec. Alarm cycles will be reset every time the alarm is disarmed or whenever the panic alarm is activated.

#### 4.8 - SELF-REARMING

When the system is armed and then accidentally disarmed, the system will automatically rearm 35 sec. after it has been unintentionally disarmed.

#### 5.0 - SLEEP MODE - ENERGY SAVER FEATURE

In order to preserve battery life, the system will automatically revert to sleep mode when the vehicle is sitting idle for a period of time.

##### **IF THE SYSTEM IS DISARMED:**

The system will go into sleep mode, 72h after it has been disarmed or engine has been switched OFF. Remote controls will be inoperative during sleep mode: normal operation is **automatically** restored upon turning ignition ON.

To manually activate this feature before 72h, proceed as follows:

- Turn ignition key in "ON"; the LED will light up for approx. 1 sec.
- Within 4 sec. of the LED flash, simultaneously press both remote control buttons; 1 Beep will confirm the system has entered sleep mode.
- Turn ignition key "OFF".
- To wake up the system, cycle ignition key "ON" and "OFF".

##### **IF THE SYSTEM IS ARMED:**

The system will **automatically** go into sleep mode 72h after it has been armed. All protection features are operative during sleep mode except the status LED.

Remote controls are inoperative, normal operation is restored when ignition is switched ON.

When the engine is switched ON, there is a 5 sec. delay to allow disarming without triggering the siren.

#### 6.0 - HAZARD WARNING FLASHERS

To make the turn indicators flash as Hazard warning lights, proceed as follows:

With the system disarmed, turn ignition key in "ON"; the LED will light up for approx. 1 sec.

- While the LED is ON, press remote control button "1".
- Turn ignition key "OFF"; the turn indicators will start flashing.
- To disable the flashers, turn ignition key "ON" (and eventually "OFF") or arm the system.

## 7.0 - PIN CODE OVERRIDE

If you cannot disarm the system from the remote controls because they are lost or broken or batteries are flat, you will be able to disarm the system by using the PIN override procedure.

For security reasons, we recommend that you change the 4-digit PIN code from the factory setting 1-1-1-1 (par. 9.0).

To override the system:

- Trigger an alarm condition. After the warning signals, the status LED will turn ON steady for approx. 5 sec.
- While the LED is ON, cycle ignition key ON and then OFF.

### CAUTION

If ignition key stays in the ON position for more than 5 sec., the system will interpret the situation as a theft attempt and trigger another alarm.

- The status LED will turn OFF to confirm the system is in override mode.
- 4 sec. after the LED has powered OFF, there will be a sequence of 9 LED flashes.
- Count the number of flashes and, at the number of flashes that equals the PIN 1st digit, cycle ignition key ON and OFF to confirm the entered digit.
- After 4 seconds, there will be another sequence of LED flashes.
- When the number of flashes equals that of the 2nd digit, cycle ignition key ON and OFF to confirm the entered digit.
- Repeat the above steps for the remaining two digits.
- If the code has been entered correctly, the system will disarm and signal the last cause of alarm (par. 3.11, "System disarming with alarm memory").

### CAUTION

If the LED blinks more than 9 times, the procedure will be invalidated and considered a theft attempt.

## 8.0 - PIN CODE OVERRIDE EXAMPLE

To help you understand the override procedure by PIN code, here below is a step-by-step example entering PIN code "2-3-4-1".

Arm the system. After the arming delay, trigger an alarm condition.

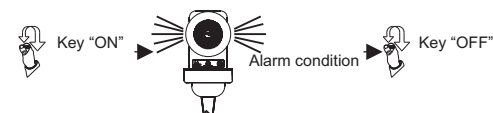

After the alarm warnings are over, the status LED will turn ON steady for approx. 5 sec. While the LED is ON, cycle ignition key ON and OFF; the LED will go OFF to confirm the system is in PIN override mode.



After 4 sec. the LED will flash 9 times in sequence. Count the number of flashes and cycle ignition key ON and OFF when the number of flashes equals that of the 1st digit (in this case "2").

After 4 sec., there will be another sequence of LED flashes. Cycle ignition key ON and OFF after the 3rd blink (PIN code 2nd digit "3").

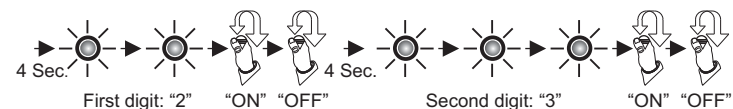

Repeat the above steps for the remaining two digits ("4" and "1").

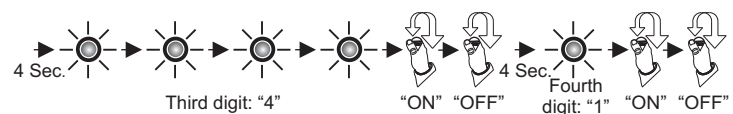

If the PIN code has been entered correctly, the alarm system will disarm and signal the last cause of alarm (see par. 3.11).

If the LED blinks more than 9 times, the procedure will be invalidated and considered a theft attempt.

## 9.0 - PIN CODE CUSTOMIZATION

Here below is a step-by-step example showing how to customize the factory PIN code. In this case the selected PIN code is **2-3-4-1**.

Disarm the alarm system.

Ground the BROWN-GREEN wire. Open the seat (if protected by a contact switch).

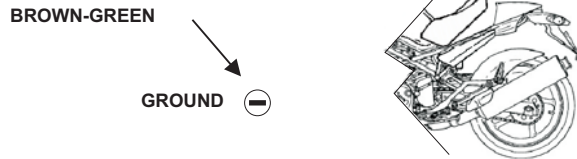

Turn ignition key "ON".



The status LED will light up for approx. 1 sec.  
While the LED is ON, simultaneously press both remote control buttons.  
2 Beeps will sound and the LED will power ON steady.

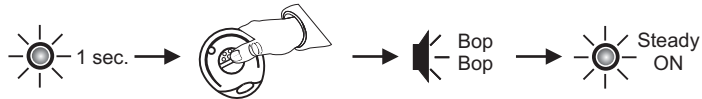

Disconnect the BROWN-GREEN wire. Close the seat if previously opened.

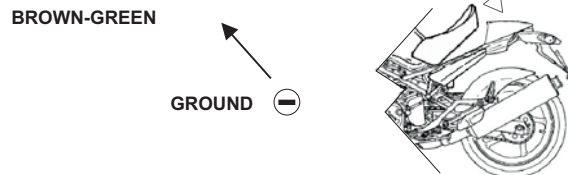

Simultaneously press both remote control buttons.  
The LED will turn OFF.



Turn ignition key "OFF".



After 4 sec., the LED will flash 9 times in sequence.  
Count the number of flashes and cycle ignition key ON and OFF when the number of flashes equals that of the new PIN code 1st digit.

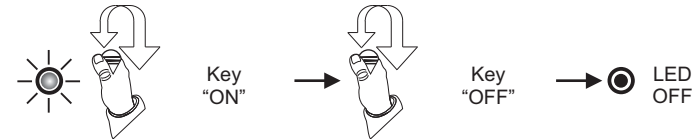

After 4 sec., there will be another sequence of LED flashes.  
Repeat the above step to enter the 2nd digit.

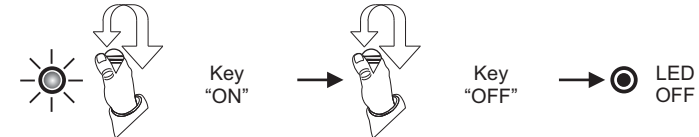

Repeat the above steps to enter the last 2 digits.  
When the 4th digit is entered, the system automatically exits the procedure.  
2 Bops and 1 Beep will confirm the code has been entered successfully.

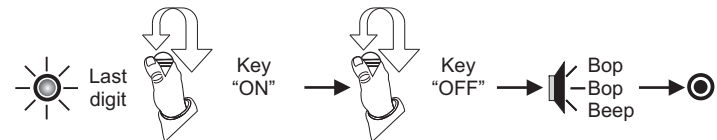



### 10.0 - REPLACING REMOTE CONTROL BATTERIES

When the remote control batteries are too weak (see par. 2.0), replace them as follows:

- Separate the remote shells taking care not to damage the internal circuit.
- Remove the discharged batteries.
- Insert the new batteries taking care not to invert polarity.
- Close the remote shells.
- Make sure the remote control works properly.

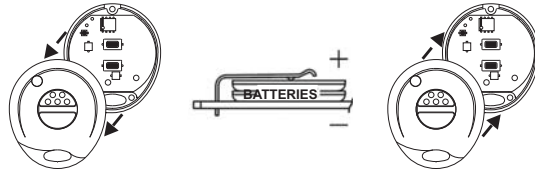

#### ⚠ WARNING

Use only CR1616 batteries.  
There is a serious risk of explosion if batteries are replaced by an incorrect type.  
Different type batteries can also seriously damage the remote control unit.  
Discard used batteries properly in special dedicated containers.

### 11.0 - TECHNICAL SPECIFICATIONS

Power supply	12 Vdc
Power supply range	9Vdc-15Vdc
Current absorption @ 12Vdc	<2mA (system armed and LED flashing)
Current absorption in <i>sleep mode</i>	< 1mA
Siren sound level	118 dBA @ 1 m
Relay capacity	8A
Turn indicator output	12V max. (6A per side)

### 12.0 - WASTE ELECTRICAL AND ELECTRONIC EQUIPMENT (WEEE) DIRECTIVE

The present device does not fall within the scope of Directive 2002/96/EC on Waste Electrical and Electronic Equipment (WEEE) as specified in art. 2.1 of Leg. Decree n. 151 of 25/07/2005.

### 13.0 - USE AND MAINTENANCE

Care should be taken to protect the electronic alarm system:

- Do not clean the alarm unit with water but use a damp cloth to wipe.
- Do not use voltages other than the one specified by the manufacturer.
- Protect the alarm from any direct water flow such as high-powered water jets found in a car wash.

#### ⚠ ATTENTION

Gemini Technologies will not be held responsible for any damage caused by improper use.

### 14.0 - WARRANTY CONDITIONS

This product is guaranteed for 24 months from the date of purchase in accordance with the provisions set forth in Leg. Decree n.206 dated September 6, 2005 ("Italian Consumer Sales Code") and subsequent amendments.

The product certificate, duly completed and accompanied by the original sales receipt will constitute proof of purchase.

The warranty shall be void if labels on the product or on the certificate are missing or torn, if the certificate is not fully completed or if the enclosed sales receipt is missing.

The manufacturer is **NOT** responsible for any aspect of installation, after-sales service and/or technical support and, should these services be included in the sales contract, they will be the exclusive responsibility of the retailer.

Consumers who need to enforce their statutory consumer guarantee rights against defective products - in accordance with Art. 128 et seq. of the Italian Consumer Sales Code (Leg. Decree n.206 as above)- must personally contact the retailer.

The manufacturer declines any responsibility for eventual malfunctions or failures of the product and/or any damage whatsoever caused by improper installation, use or tampering.

This alarm system is solely intended to be a theft-deterrent device.

## INSTALLER MANUAL

### 15.0 - FITTING INSTRUCTIONS

Please read all instructions and understand them thoroughly before starting the installation.

The present manual is to be considered an integral part of the alarm system.

### 16.0 - ALARM UNIT SEALING

To seal the alarm, position the rubber cap over the external edge of the alarm housing as shown below. Pull the plastic rectangular flange over the rubber cap and secure with the supplied screws. Do not over tighten the screws.

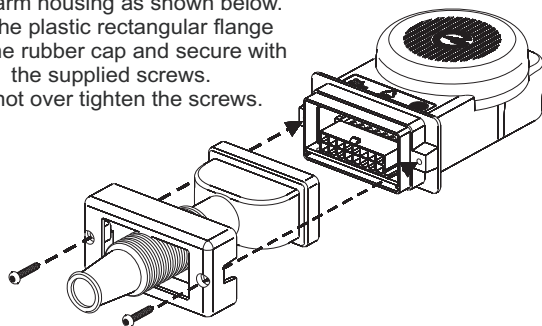

Alarm unit sealed

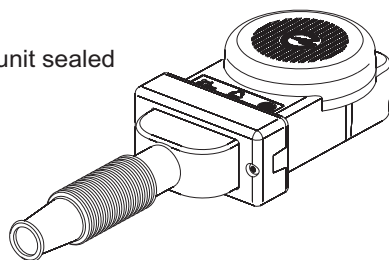

### 17.0 - ALARM UNIT POSITIONING

The alarm can be positioned either vertically or horizontally as long as you keep the following in mind:

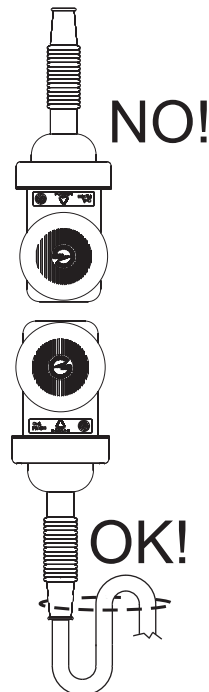

Do not install the alarm unit in this position as water ingress over time may seep through the rubber sheath and permanently damage the electronic circuit making the alarm unreliable.

Eventual malfunctioning due to water infiltration is not covered by warranty.

- Fitting the alarm in this position will prevent water entering the unit.
- It is important to give the rubber sheath a "goose-neck" bending as shown in the picture opposite and secure with a tie wrap.
- Do not expose to atmospheric agents.
- Pay attention not to muffle the siren speaker.
- Secure away from moving mechanical parts.
- Keep away from devices that could generate high frequency electromagnetic disturbances.
- Keep away from devices that could reach high temperatures when the vehicle is in use.
- Do not secure the alarm unit directly on the vehicle frame.

#### ⚠ ATTENTION

Do not jet wash the alarm ECU. The warranty will not cover damages to the alarm system due to water ingress caused by improper installation or jet washing.

## 18.0 - ACCESSORIES

### 18.1 - STATUS LED

Since the LED warning light serves as both a system status indicator and a visual deterrent it must be installed where it can readily be seen.

Always check the rear clearance before drilling:

- Drill a  $\varnothing$  10mm hole and insert the LED holder.
- Gently press the LED holder until it clicks into place.
- Connect the LED Black 2-pin connector to the alarm Black 2-pin connector.
- Bundle up and tie down any excess wires.

### 18.2 - CONTACT SWITCH (OPTIONAL)

A contact switch can be fitted to protect the seat or topcase. It must be installed in such a way as to detect the opening of the seat/topcase without being accessible from the outside.

The trigger threshold must be carefully set to avoid false alarms.

Do not ground the switch terminal to the vehicle chassis as it might not be earth grounded. Connect to a wire that provides continuous ground such as the turn indicator lamp negative lead.

**NB:** If no contact switch is fitted, the GREEN/BROWN wire will remain free for other possible uses such as programming the alarm or learning new devices.

### 18.3 - ANTI-HIJACK BUTTON (OPTIONAL)

Connect the anti-hijack button to the White-Violet wire. The anti-hijack will trigger when a negative signal is detected.

## 19.0 - PINOUT TABLE

### ⚠ ATTENTION

This alarm system is intended for 12V turn indicators. Before you do any electrical work, make sure the flashers are powered by a 12V signal.

### CAUTION

Alarms are supplied without wiring harnesses. A wide range of specific pin-to-pin wiring harnesses is available for the most common motorbikes. The following tables refer to the generic wiring harness KITCA 417N17.

Pos.	Wire color	Wire function
- 1 -	---	N/A
- 2 -	Brown	Power supply earth ground
- 3 -	White-Violet	LEARN button / Anti-hijack
- 4 -	Green-Brown	Contact switch input
- 5 -	---	N/A
- 6 -	---	N/A
- 7 -	Yellow	Ignition
- 8 -	Black	LED negative output
- 9 -	---	N/A
- 10 -	Grey	Immobilizer (N.C.)
- 11 -	White	Immobilizer (Com.)
- 12 -	White-Grey	Immobilizer (N.O.)
- 13 -	Orange	Turn indicators (12V)
- 14 -	Red	Positive supply
- 15 -	Orange	Turn indicators (12V)
- 16 -	Black	Antenna

### IMMOBILIZER - wire joint

Wire color	Connections
White	Attach to cut end of key switch wire.
Grey	Attach to cut end of main wiring harness.

### IMMOBILIZER - grounded wire

Wire color	Connections
White	Connect to a permanent negative connection (do not connect to vehicle chassis).
White/Grey	Connect to the cable end which, if grounded, will kill the engine.

## 20.0 - WIRING DIAGRAM

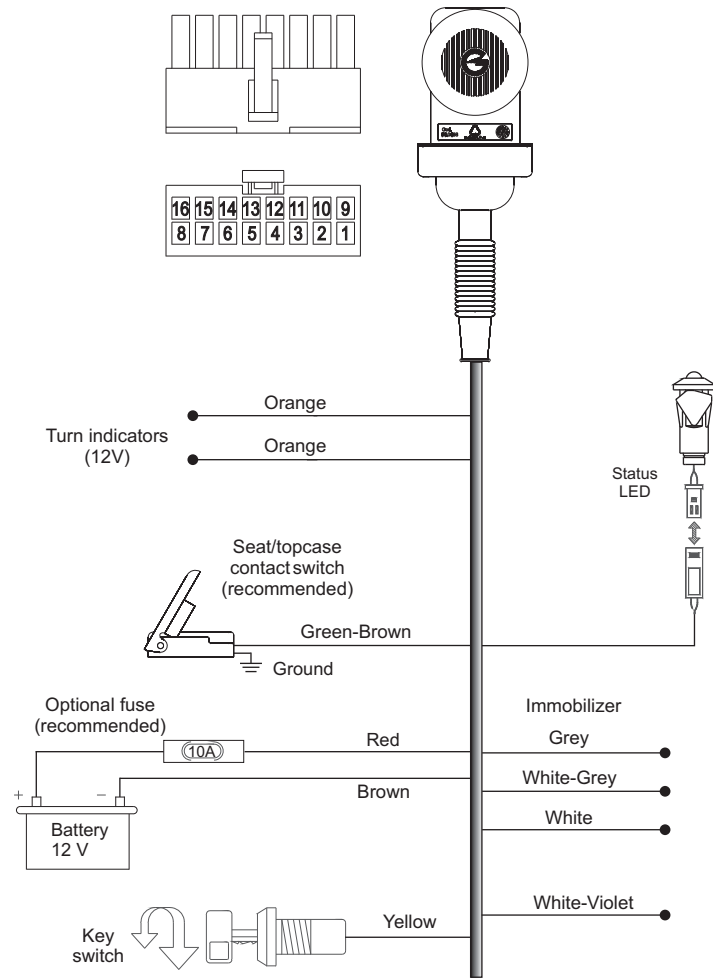

## 21.0 - IMMOBILIZER WIRING DIAGRAM

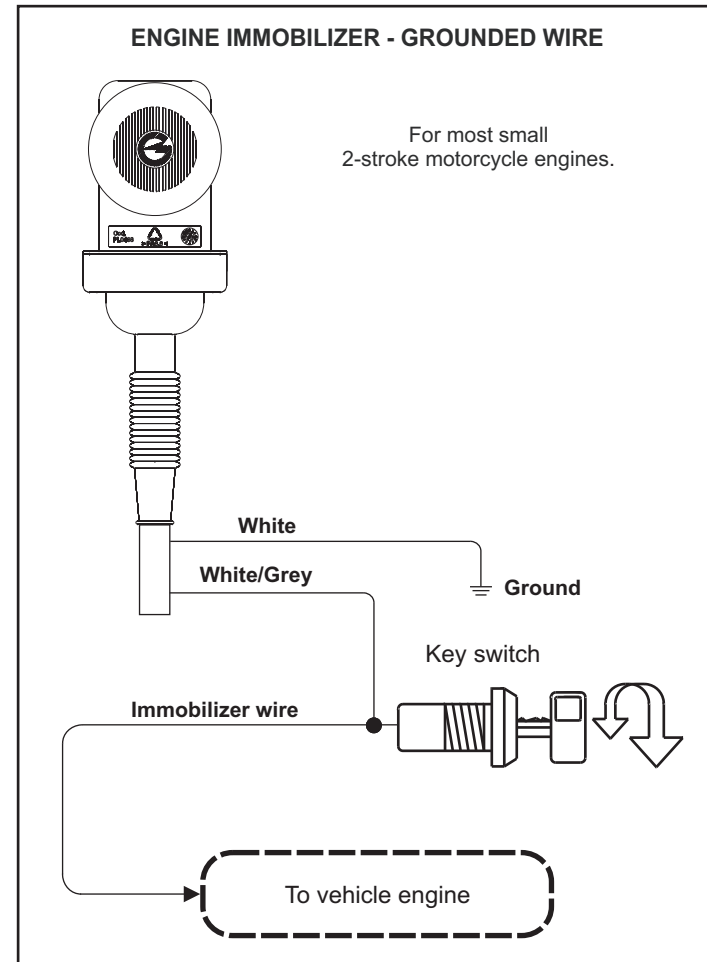

## 22.0 - IMMOBILIZER WIRING DIAGRAM

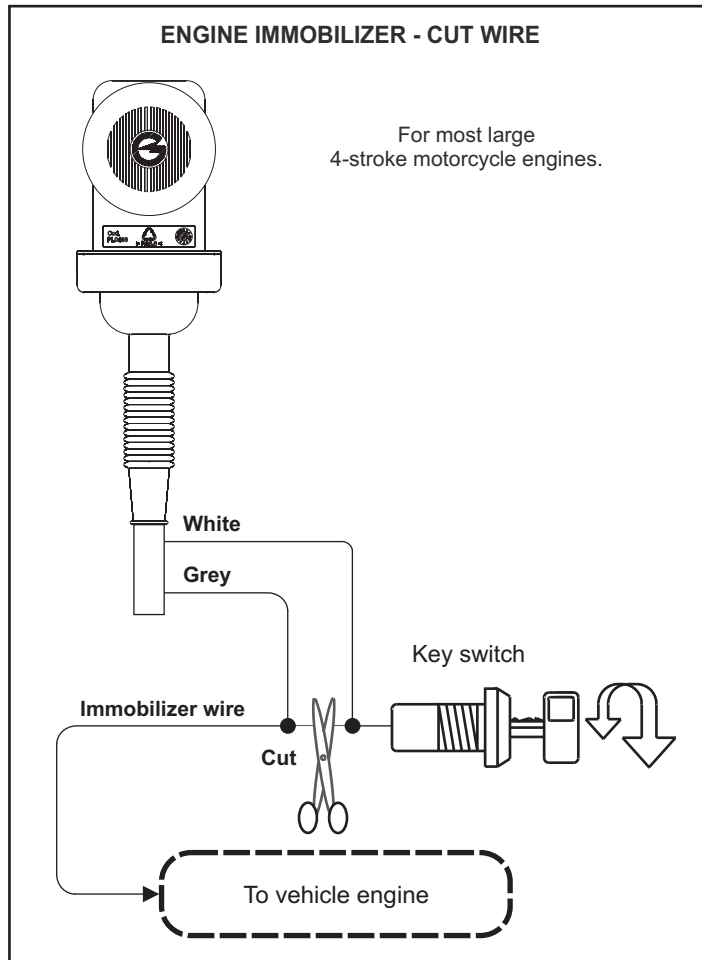

## 23.0 - DIODE INSTALLATION

How to tell if you need to install a diode:

- Activate one of the turn indicators, turn ignition key OFF and arm the alarm.
- If the instrument panel lights up when the turn indicators are activated, a diode needs to be installed (follow diagram below).

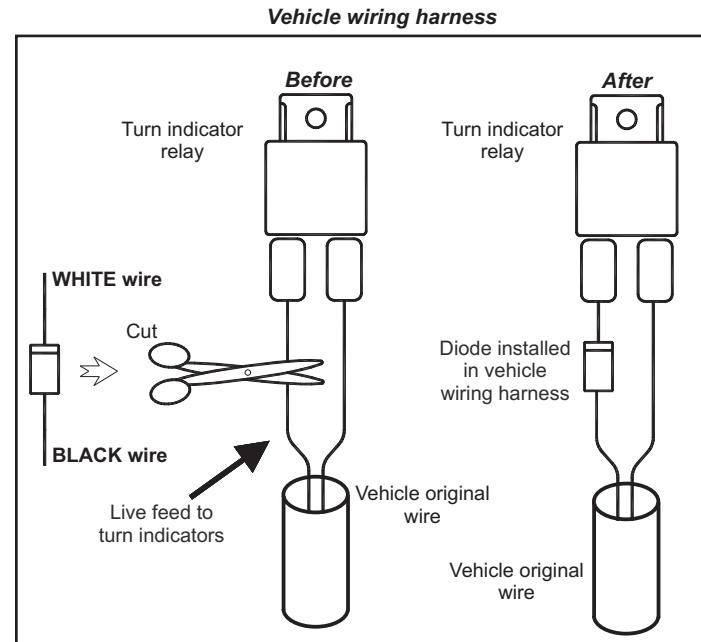

#### **24.0 - LEARNING NEW DEVICES**

The alarm system is supplied with 2 remote controls but extra remotes can be added.

To learn new devices, make sure passive arming is NOT enabled. Proceed as follows:

##### **CAUTION**

Alarm memory will only store 8 devices.  
Saving an extra device will automatically delete the first one.

#### **24.1 - BY GROUNDING THE BROWN/GREEN WIRE:**

- Disarm the alarm system via remote control.
- Lift the seat or open the topcase (if fitted with a contact switch) otherwise ground the BROWN/GREEN wire.
- Ground the White-Violet wire (some will have a Yellow end connector).
- Turn ignition key in ON.
- 2 flashes of the turn indicators and 2 confirmation tones (1 Bop and 1 Beep) will acknowledge the system is in learn mode.
- Disconnect the White-Violet wire.
- Press one of the buttons on the remote control to be learned.
- A flash of the turn indicators and a Beep will confirm the new remote has been learned.
- If other remote controls need to be learned, repeat the above procedure then press the button on the remote control to be learned.
- To exit the learn procedure, turn ignition key OFF. A Bop and a single flash of the turn indicators will confirm the end of the procedure.
- Close the seat/topcase or remove the BROWN/GREEN wire from ground.





#### **24.2 - WITHOUT GROUNDING THE BROWN/GREEN WIRE:**

- Disarm the alarm system via remote control.
- Turn ignition key in ON.
- The status LED will light up for 1 sec.; while the LED is ON, simultaneously press both buttons on the remote control.
- 2 flashes of the turn indicators and 2 confirmation tones (1 Bop and 1 Beep) will acknowledge the system is in learn mode.
- Press one of the buttons on the remote control to be learned.
- If other remotes need to be learned, wait 2 sec. and then press one of the buttons on the remote control to be learned.
- To exit the learn procedure, turn ignition key OFF.
- A Bop and a single flash of the turn indicators will confirm the end of the procedure.

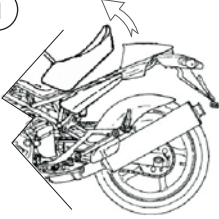

## 25.0 - PROGRAMMABLE FEATURES

To either enable or disable one of the programmable features, proceed as follows:

**NB: Remember to ALWAYS arm/disarm the system before programming.**

<p><b>1</b></p> 	<p>With the system disarmed, lift the seat or open the topcase (if protected by a contact switch) otherwise ground the GREEN/BROWN wire. NB: Remove the wire from ground after programming.</p>
<p><b>2</b></p> 	<p>Turn ignition key in ON.</p>
<p><b>3</b></p> 	<p>The status LED will light up for approx. 1 sec.</p>
<p><b>4</b></p> 	<p><b>While the LED is ON</b>, simultaneously press both remote control buttons. Two confirmation tones (1 Bop and 1 Beep) will acknowledge the system is in programming mode. The LED will light up steady.</p>

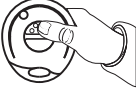
After pressing both buttons simultaneously (step 4), program the features according to your needs.

TO ENABLE	TO DISABLE
Press button 1 	 Press button 2
<b>ACOUSTIC SIGNALS</b> (factory enabled)	Button 1: ENABLE Button 2: DISABLE
<b>PANIC ALARM</b> (factory enabled)	Button 1: ENABLE Button 2: DISABLE
<b>TILT SENSOR</b> (factory enabled)	Button 1: ENABLE Button 2: DISABLE
<b>PASSIVE ARMING</b> (factory disabled)	Button 1: ENABLE Button 2: DISABLE
<b>ANTI-HIJACK</b> (factory disabled)	Button 1: ENABLE Button 2: DISABLE
<b>PRE-ALARM</b> (factory disabled)	Button 1: ENABLE Button 2: DISABLE
<b>SYSTEM SELF-REARMING</b> (factory disabled)	Button 1: ENABLE Button 2: DISABLE
EXIT PROGRAMMING	

## 26.0 - PROGRAMMING EXAMPLE

Here below is a step-by-step example showing how to program the system with the acoustic signals, the panic alarm and the pre-alarm features enabled.

Keep in mind that, at every button press, the system automatically scrolls to the next feature.

- With the system disarmed, lift the seat/topcase (if protected by a contact switch) otherwise ground the BROWN/GREEN wire.
- Turn ignition key in ON; the LED will light up for approx. 1 sec.
- While the LED is ON, simultaneously press both remote control buttons; 2 Beeps will confirm the system is in programming mode. The LED will also light up steady.
- Press remote control button 1; a Beep will confirm **acoustic signals** have been enabled.
- Press remote control button 1; a Beep will confirm that the **panic alarm** has been enabled.
- Press button 2; a Bop will confirm that the **tilt sensor** has been disabled.
- Press button 2; a Bop will confirm that **passive arming** has not been enabled.
- Press button 2; a Bop will confirm that the **anti-hijack feature** has not been enabled.
- Press button 1; a Beep will confirm that the **pre-alarm feature** has been enabled.
- Press button 2; a Bop will confirm that **self-rearming** has not been enabled.
- When the last feature has been configured, the system automatically exits the programming procedure; 2 Bops and 1 Beep will confirm the end of the procedure. The status LED will power OFF.
- Turn ignition key OFF, close the seat/topcase or remove the BROWN-GREEN wire from ground.

### CAUTION

You can exit the programming procedure at any time by turning ignition key OFF.  
Programmed features will automatically be saved while the others will remain unvaried.

## R&TTE Declaration of Conformity

Doc ref. No. 2010-01

We, the undersigned,

Company	GEMINI TECHNOLOGIES S.r.l
Address, City	Via Luigi Galvani 12, 21020 Bodio Lomnago (VA)
Country	Italy
Phone number	+39 0332 943211
Fax number	+39 0332 948080

Declare under our sole responsibility that the following equipment:

Product description: Intended use:	Remote control at 433,92 Mhz For vehicle alarm systems
EU / EFTA member states intended for use	EU: all members EFTA: all members
Member states with restrictive use	None
Manufacturer	GEMINI TECHNOLOGIES S.r.l.
Brand name	GEMINI
Type / Model	7208E and 7218E

Is tested to and conforms with the essential requirements of Art. 3.1 (a) for protection of Health and Safety of the user and any other person and of Art. 3.1 (b) for Electromagnetic Compatibility, as included in the following standards:

Art. of Directive	Standard	Date of issue
3.1 (a) Health	EN 50371	2002
3.1 (a) Safety	EN 60950-1 +A11	2006; 2009
3.1 (b) EMC	EN 301 489-3	V2.1.1 (2009-05)
3.1 (b) EMC	E. 301 489-1	V1.8.1 (2008-04)

And is tested to and conforms to Art. 3.2, with the essential radio test suites so that it effectively uses the frequency spectrum allocated to terrestrial/space radio communication and orbital resources so as to avoid harmful interference, as included in the following standards:

Art. of Directive	Standard	Date of issue
3.2 Spectrum	EN300 220-2	V2.3.1 (2010-02)

And therefore complies with the essential requirements and provisions of **Directive 199/5/EC** of the European Parliament and of the Council of March 9, 1999 on radio equipment and telecommunications terminal equipment and the mutual recognition of their conformity and with the provisions of Annex II.



TCF reference n°	TCF_ 7208E/7218E
Date	August 23, 2010
Name and position	Andrea Rossi, Managing Director